

SPECIFICATION SHEET

ARCO 1500 4 DRAW SINGLE BASIN WALL HUNG
CAPRI J HANDLES

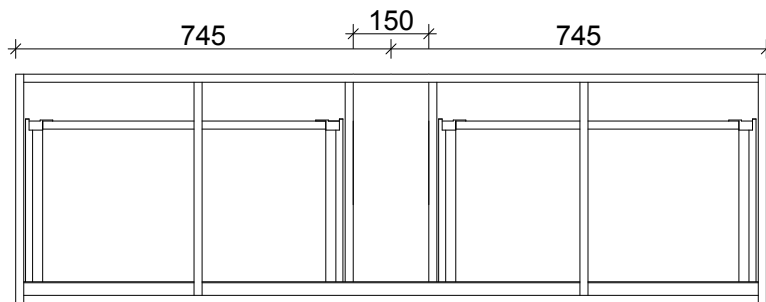

TOP VIEW OF CABINET

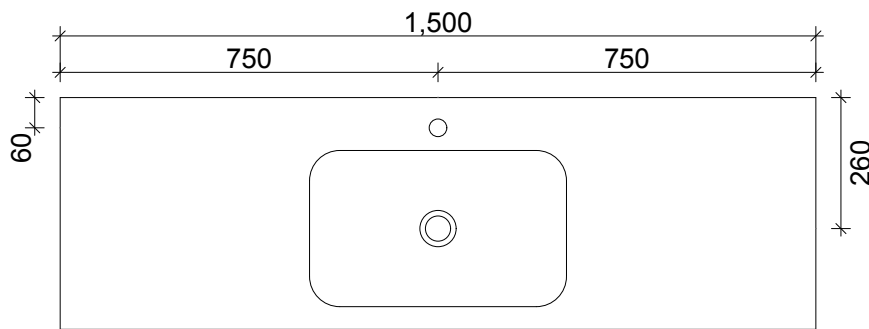
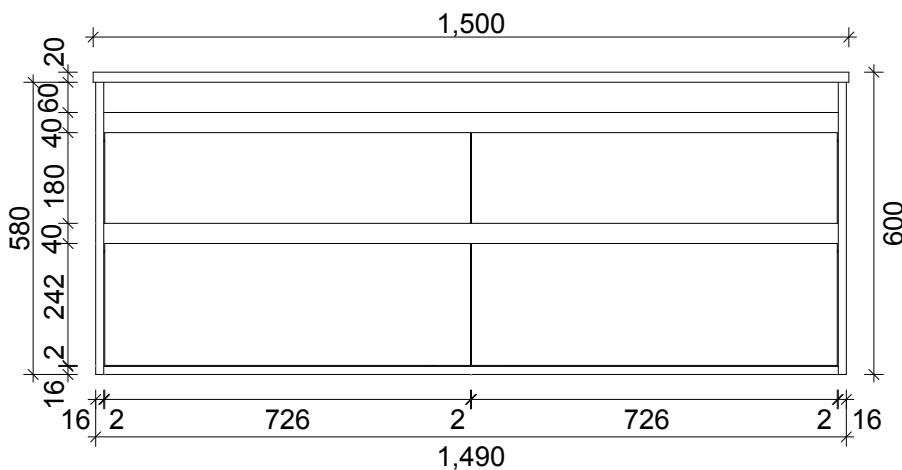
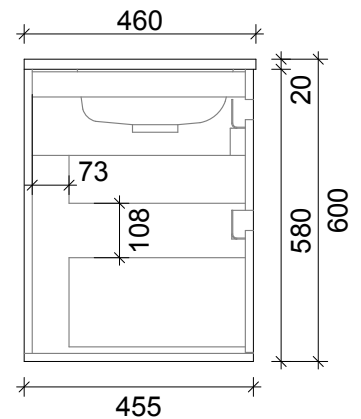
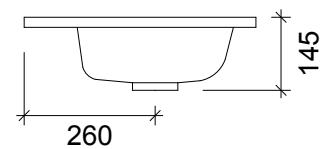

PRIMO BATHROOMWARE
3 EDISON PLACE
(03) 384-2471
EMAIL: sales@primobathroomware.co.nz