

SPECIFICATION SHEET
EDGE 1800 2 DRAW OPEN SHELF WALL HUNG

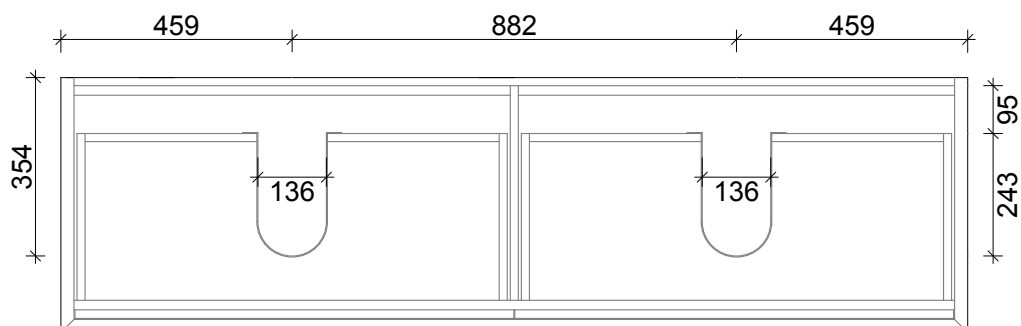

DRAWER WASTE CUT OUT

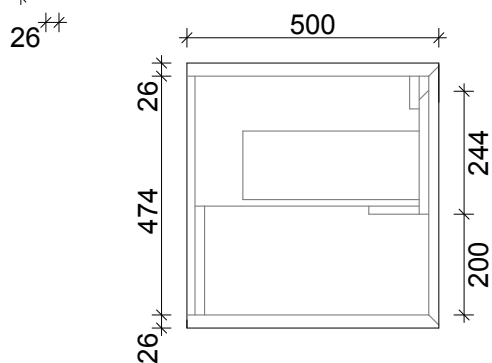
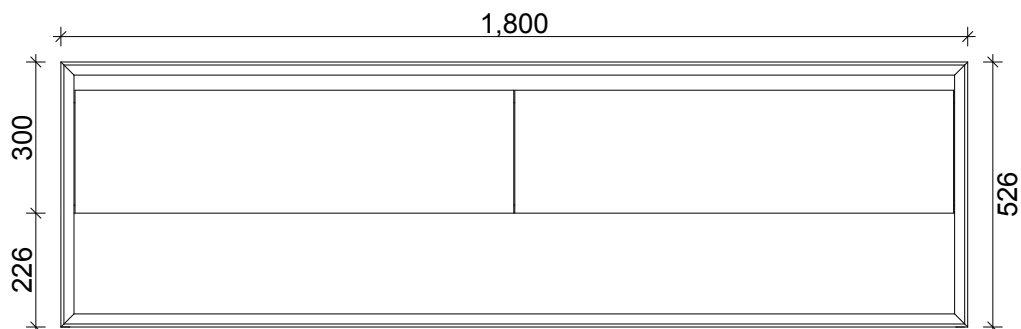

PRIMO BATHROOMWARE
3 EDISON PLACE
(03) 384-2471
EMAIL: sales@primobathroomware.co.nz