

SPECIFICATION SHEET

LARGO 1200 2 DRAW 1 DOOR RH WALL HUNG
CAPRI J HANDLES

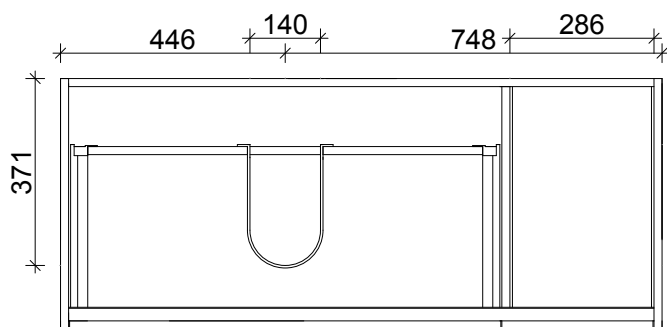

DRAWER WASTE CUT OUT

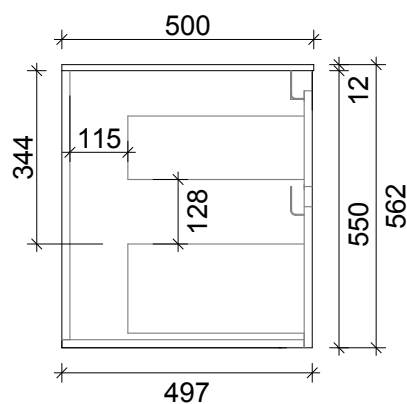
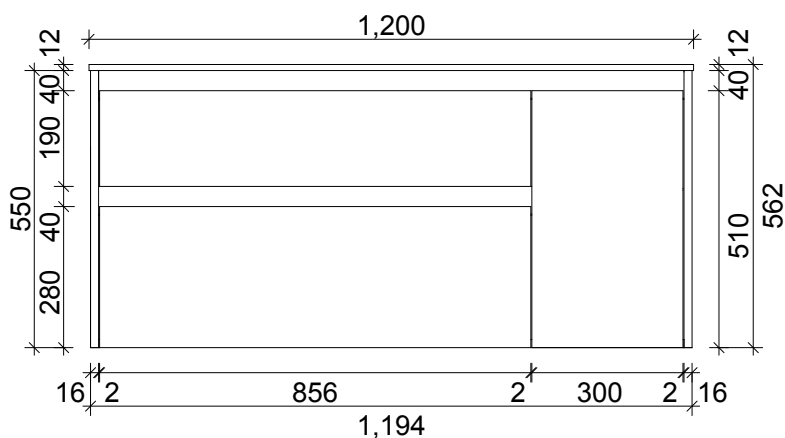

PRIMO BATHROOMWARE

3 EDISON PLACE

(03) 384-2471

EMAIL: sales@primobathroomware.co.nz