

SPECIFICATION SHEET

LARGO 1500 2 DRAW 1 DOOR RH WALL HUNG
CAPRI J HANDLES

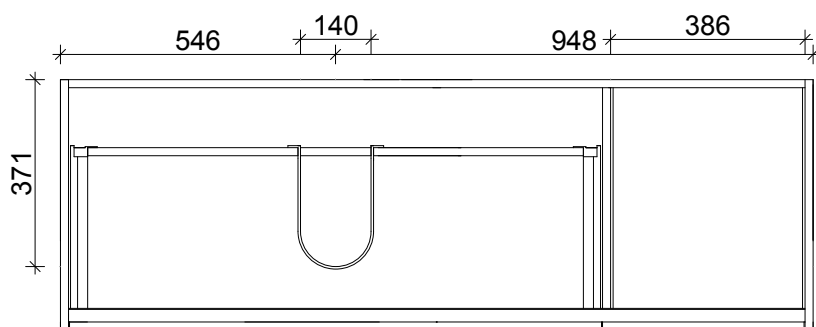

DRAWER WASTE CUT OUT

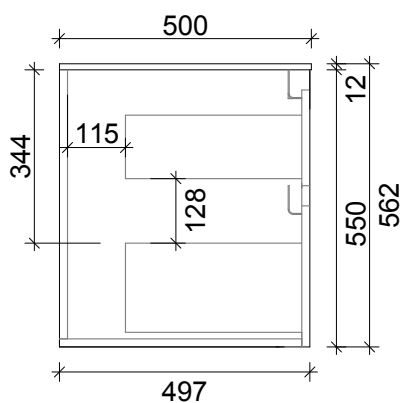
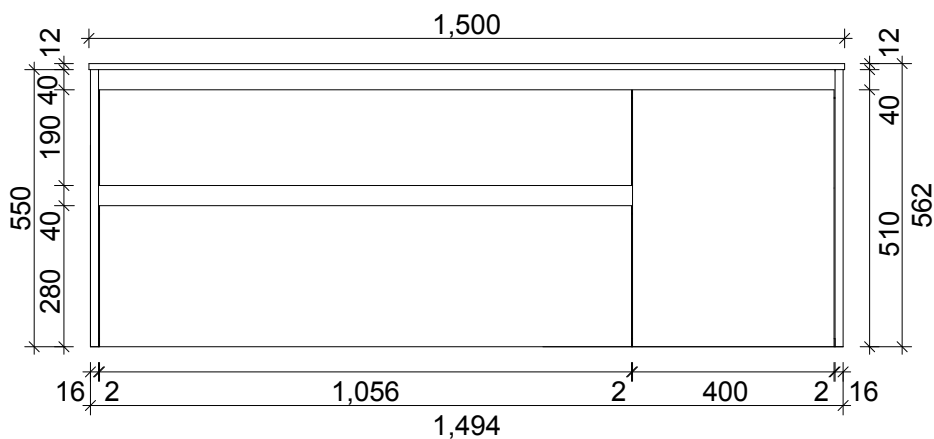

PRIMO BATHROOMWARE
3 EDISON PLACE
(03) 384-2471
EMAIL: sales@primobathroomware.co.nz