

SPECIFICATION SHEET
LARGO 1500 4 DRAW WALL HUNG CAPRI J HANDLES

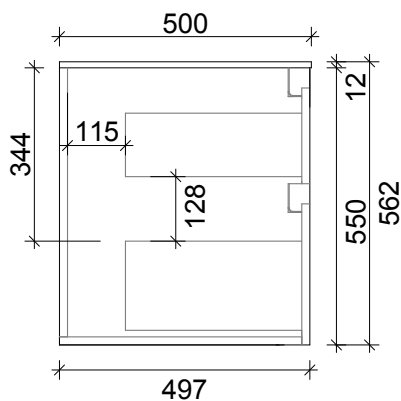
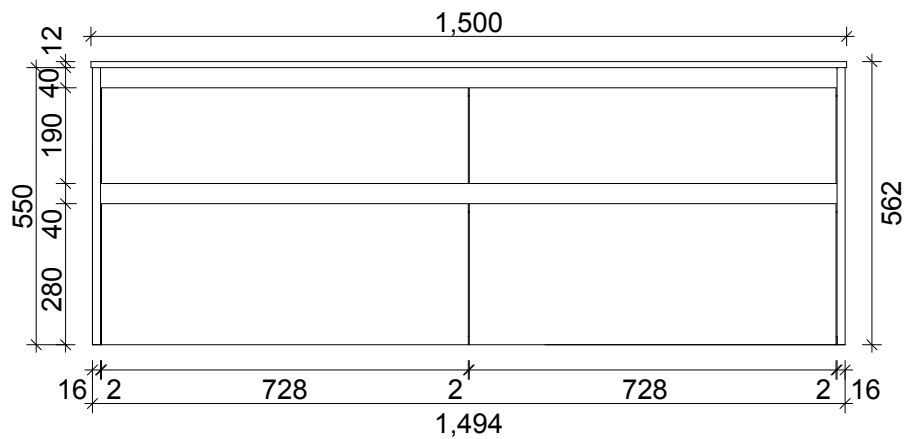
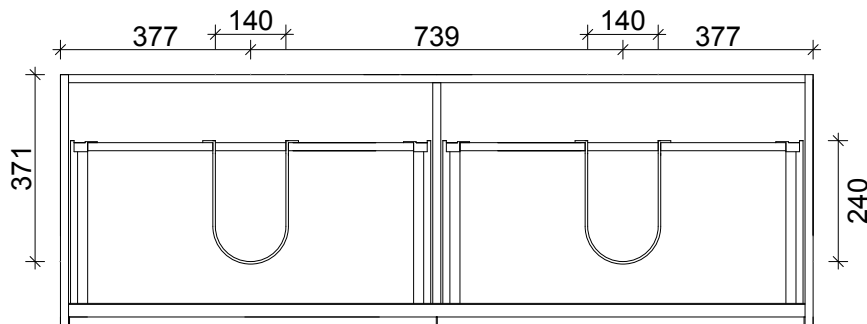

PRIMO BATHROOMWARE
3 EDISON PLACE
(03) 384-2471
EMAIL: sales@primobathroomware.co.nz