

SPECIFICATION SHEET
PINTO 900 2 DRAW 1 DOOR WALL HUNG RIGHT HAND

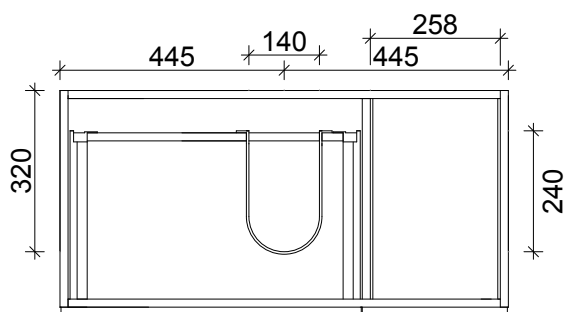

DRAWER WASTE CUT OUT

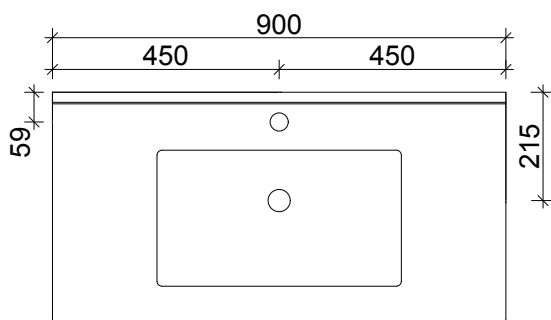
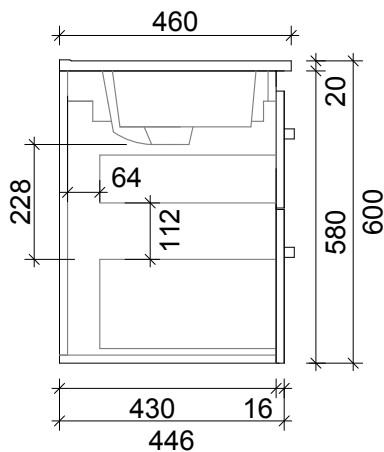
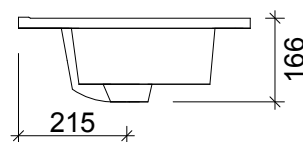
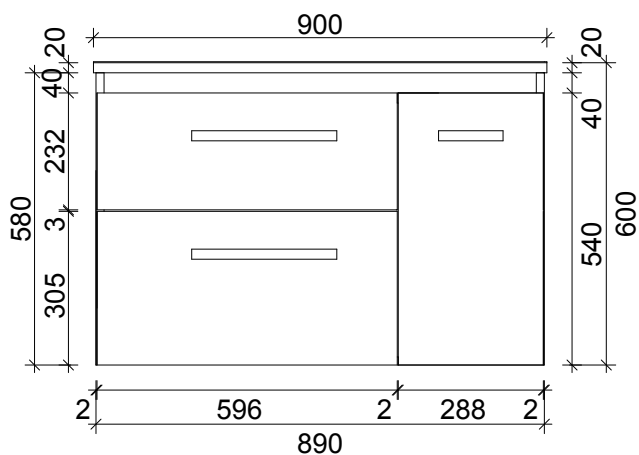

PRIMO BATHROOMWARE
 3 EDISON PLACE
 (03) 384-2471
 EMAIL: sales@primobathroomware.co.nz