

SPECIFICATION SHEET

SAIL 950 1 DRAW WALL HUNG

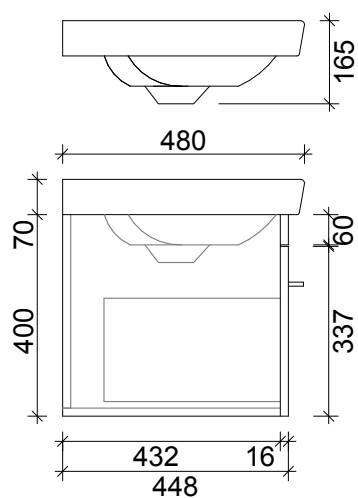
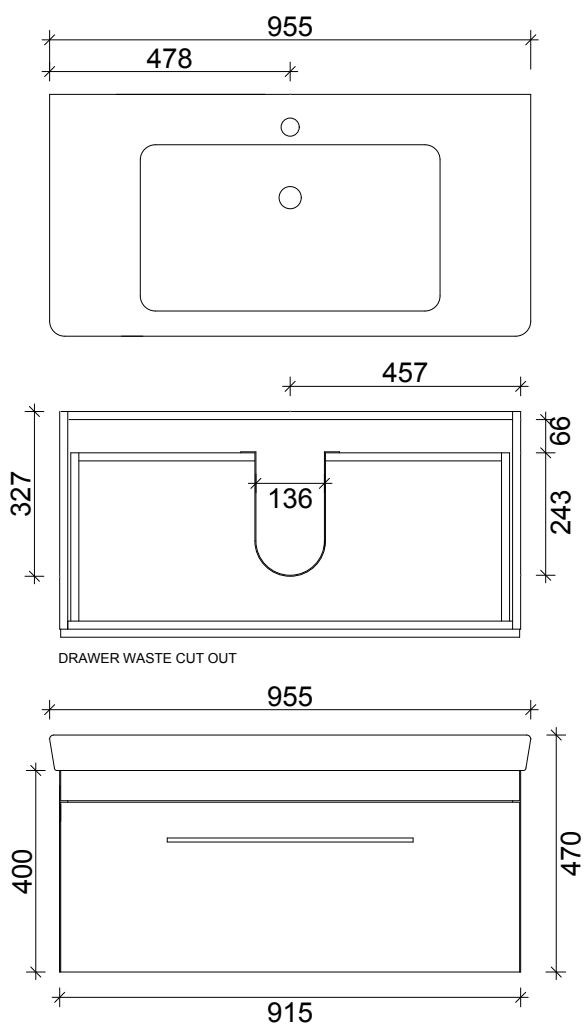

PRIMO BATHROOMWARE
3 EDISON PLACE
(03) 384-2471
EMAIL: sales@primobathroomware.co.nz